

Z-M/L2 15WAY CAP W/MALES

PINK	1
GRY/BLK	2
BROWN	3
BRN/BLU	4
BRN/BLK	5
BRN/ORN	6
BRN/WHT	7
BLACK 12GA	8
GRAY	9
WHT/BLU	10
TAN	11
TAN/BLU	12
BRN/RED	13
ORN/GRY	14
RED 10GA	15

Y-M/L2 6 WAY CAP W/MALES

BLK 10GA	1
BLU/WHT	2
GRN/WHT	3
RED/ORN 10GA	4
ORANGE 10GA	5
RED/WHT	6

F-M/L2 2 WAY CAP W/MALES

ORN/GRN	1
----	2

6-23-15 REV.A PER CRAIG	CHANGED TO 4 WAY HD CRANK GRND BAR REVISED FUSEBLOCK DROPS ADDED TUBING ADDED 5" TO 12V/USB DROP
2-1-16 REV.B PER CRAIG	CHANGED TRIM DROPS TO .093 MALES WITH PLUG "S"
4-13-16 REV.C PER BT	ADDED AUTO BILGE INDICATOR (PLUG F)
8-29-16 REV.D PER GREG	CHANGED DEPTHFINDER LEADS TO 10GA ADDED 6" TO BOW DROPS
8-29-16 REV.E PER BT	CORRECTED PLUG P FOR RELAY W/DIODE
10-25-19 REV.F PER CRAIG	CHANGED HD GROUND NUTS TO LOCKNUTS

ROD LOCKER FUSEBLOCK

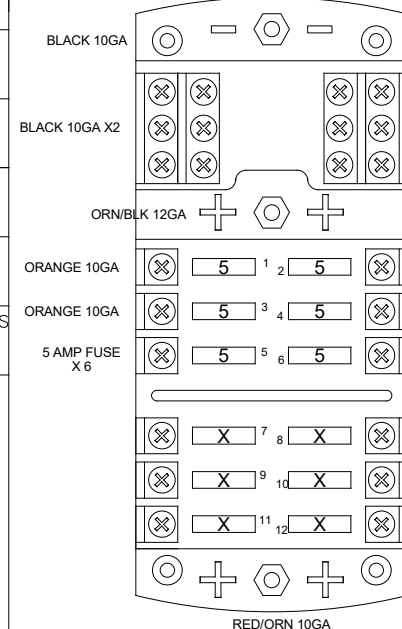

GROUND BUSS DROPS

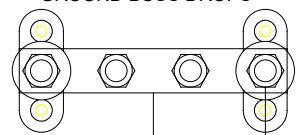

8-29-16
REV.E
PER BT

CORRECTED PLUG P FOR RELAY
W/DIODE

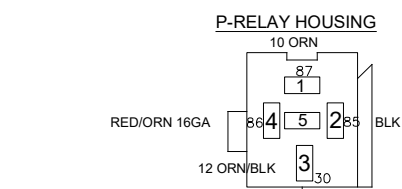

X-M/L2 6 WAY CAP W/MALES

BLK 10GA	1
GRAY	2
GRY/BLK X 2	3
ORANGE 10GA	4
ORN/GRY	5
----	6

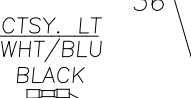
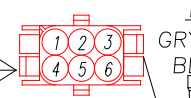

W-M/L2 3 WAY CAP W/MALES

BLUE/WHT	1
GRN/WHT	2
RED/WHT	3

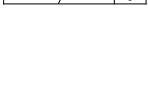

ROD LOCKER FUSEBLOCKS

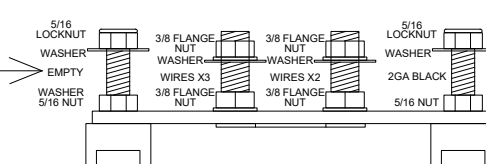
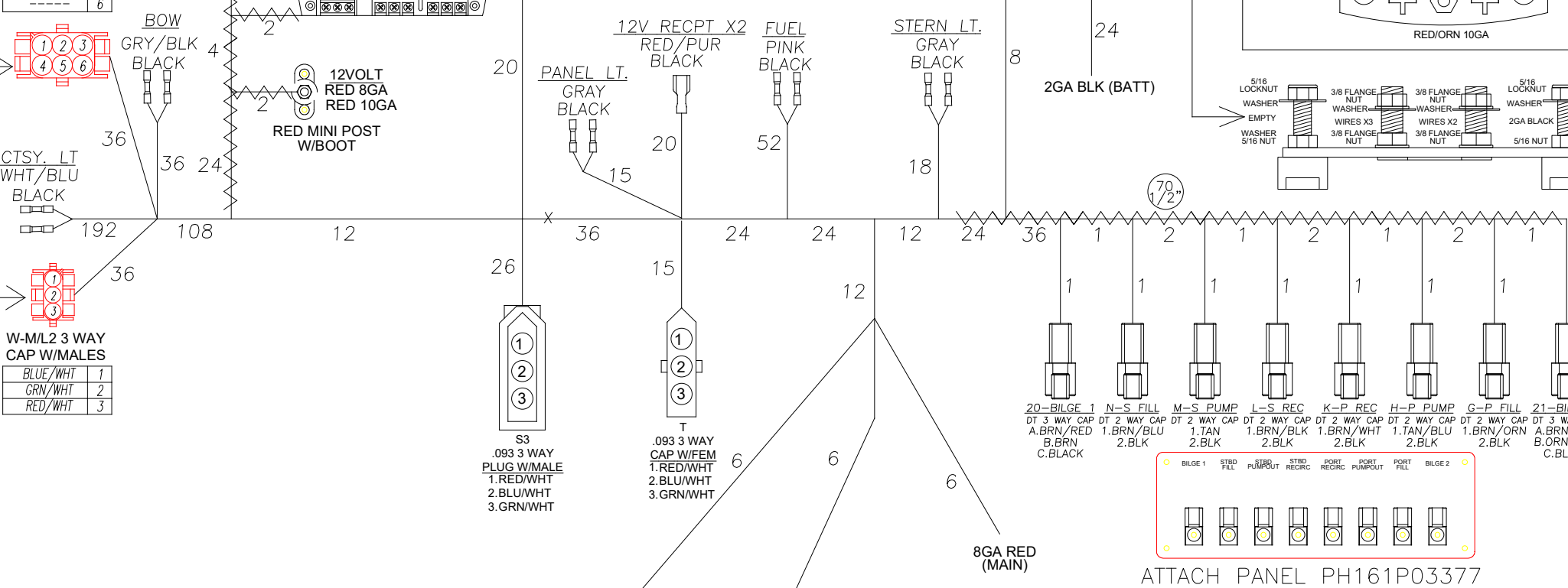
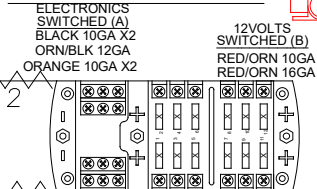

20-BILGE 1	N-S FILL	M-S PUMP	L-S REC	K-P REC	H-P PUMP	G-P FILL	21-BILGE 2
DT 3 WAY CAP	DT 2 WAY CAP	DT 2 WAY CAP	DT 2 WAY CAP	DT 2 WAY CAP	DT 2 WAY CAP	DT 3 WAY CAP	DT 3 WAY CAP
A.BRN/RED	1.BRN/BLU	1.TAN	1.BRN/BLK	1.BRN/WHT	1.TAN/BLU	1.BRN/ORN	A.BRN/RED
B.BRN	2.BLK	2.BLK	2.BLK	2.BLK	2.BLK	2.BLK	B.BRN
C.BLACK							C.BLACK

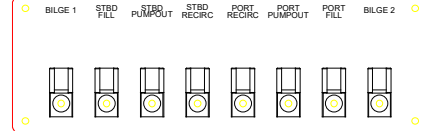

S-DT 2 WAY CAP

BRN/RED	1
BRN/RED	2



R-DTP 2 WAY CAP

ORN 10GA	1
RED/PUR 14GA	2

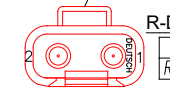

MAIN BATTERY PANEL

PAGE 5

921 DT DIST HRN
PART # PH161H01178 REV.F
PHOENIX BOATS

BH
ELECTRONICS
10-25-19
PH161H01178.DWG